

Prima[®]

List No : 41N
w.e.f. 01-04-2024

A NAME IN LUBRICATION EQUIPMENT



Lubrication equipment

www.primatools.com



Prima®

A NAME IN LUBRICATION EQUIPMENT

Company Profile

We are the largest and most successful company in our field because we continuously Satisfy our customer with the worlds best lubrication and pumping systems.

For more than 48 years companies have relied on our technical & quality leadership, our world-class manufacturing and customer service and vast network of distributors and support facilities. Prima develops new products and systems at research and development facilities in india. Germany & Italy that provide global and regional application solutions.

CONTENTS	PAGE NO.
Grease Gun.....	1 to 5
Hand Operated Bucket Grease Pump.....	06-07
Grease Gun Spares & Accessories.....	08-10
Grease Nipples.....	11
Hand Pump Accessories & Rubber Parts.....	12
Hand Pump Oiler & Accessories.....	13-14
Hand Pump.....	15-16
Garage Tools & Pneumatic Pumps.....	17-18

LEVER TYPE GREASE GUN

Cartridge / Bulk / Loading- Export Model



Cat No.	Piston	Capacity		Finish	Rate Per Pc.
RMI-G-500	5/16"	CC 445	OZ 15	Silvergrey Oven Baked	470.00

LEVER TYPE GREASE GUN NEW

Heavy Duty With Working Pressure 7000 Psi
Type of Lubricants : Light or Medium Duty Grease

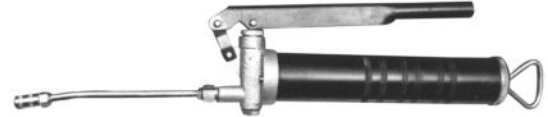

Cat No.	Piston	Capacity		Finish	Rate Per Pc.
RMI-G-507	5/8"	CC 445	OZ 15	Black	507.00

LEVER TYPE GREASE GUN

Lock Type
Type of Lubricants : Light or Medium Duty Grease

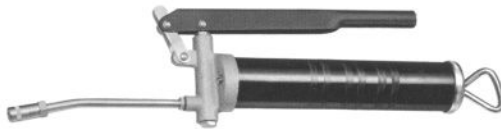

Cat No.	Piston	Capacity		Finish	Rate Per Pc.
RMI-G-501	3/8"	CC 445	OZ 15	Black	517.00

LEVER TYPE GREASE GUN

Heavy Duty
Type of Lubricants : Light or Medium Duty Grease

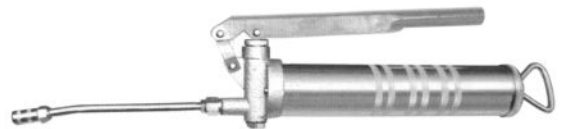

Cat No.	Piston	Capacity		Finish	Rate Per Pc.
RMI-G-507 B	5/8"	CC 445	OZ 15	Chrome Plated	546.00

LEVER TYPE GREASE GUN

Lock Type
Type of Lubricants : Light or Medium Duty Grease

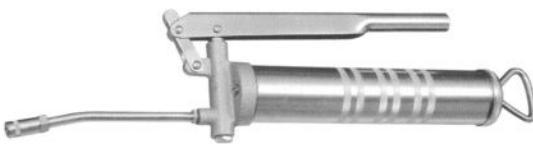

Cat No.	Piston	Capacity		Finish	Rate Per Pc.
RMI-G-501 B	3/8"	CC 445	OZ 15	Nickle Bright	551.00

LEVER TYPE GREASE GUN

Medium Size Chez. Type
Type of Lubricants : Light or Medium Duty Grease

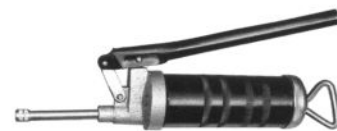

Cat No.	Piston	Capacity		Finish	Rate Per Pc.
RMI-G-508	1/4"	CC 170	OZ 8	Black	290.00

MINI LEVER TYPE GREASE GUN

Cartridge / Bulk / Loading- Export Model

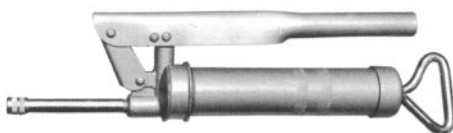

Cat No.	Piston	Capacity		Finish	Rate Per Pc.
RMI-G-502	1/4"	CC 100	OZ 4	Nickle Bright/Painted	271.00

LEVER TYPE GREASE GUN

Medium Size Chez. Type
With Hydraulic Coupler
Type of Lubricants : Light or Medium Duty Grease



Cat No.	Piston	Capacity		Finish	Rate Per Pc.
RMI-G-508 A	1/4"	CC 170	OZ 8	Black	319.00

LEVER TYPE GREASE GUN

Russian Type Type of Lubricants : Light or Medium Duty Grease					
					
Cat No.	Piston	Capacity		Finish	Rate Per Pc.
RMI-G-509	5/16"	CC 285	OZ 10	Black Painted	304.00

LEVER TYPE GREASE GUN

Deluxe Model Fitted With 8" flexible hose & Hydraulic Coupler Type of Lubricants : Light or Medium Duty Grease					
					
Cat No.	Piston	Capacity		Finish	Rate Per Pc.
RMI-G-513FH	5/16"	CC 200	OZ 8	Silvergrey	355.00

LEVER TYPE GREASE GUN

Delhi Model Type of Lubricants : Light or Medium Duty Grease					
					
Cat No.	Piston	Capacity		Finish	Rate Per Pc.
RMI-G-510	1/2"	CC 445	OZ 15	Black Painted	440.00

LEVER TYPE GREASE GUN

Superior Export Model					
					
Cat No.	Piston	Capacity		Finish	Rate Per Pc.
RMI-G-1019	3/8"	CC 500	OZ 15	Metallic Blue/ Silver Grey	540.00

LEVER TYPE GREASE GUN

Heavy Duty Export Model Cast iron head with filler nipple Type of Lubricants : Light or Medium Duty Grease					
					
Cat No.	Piston	Capacity		Finish	Rate Per Pc.
RMI-G-1010	5/16"	CC 400	OZ 14	Silver grey or Black	507.00

DUAL LEVER TYPE GREASE GUN

Export Model Suitable for use of Grease Cartridge					
					
Cat No.	Piston	Capacity		Finish	Rate Per Pc.
RMI-G-4806	5/16"	CC 650	OZ 20	Silvergrey	503.00

LEVER TYPE GREASE GUN

Deluxe Model Fitted with Hydraulic Coupler & Spout Type of Lubricants : Light or Medium Duty Grease					
					
Cat No.	Piston	Capacity		Finish	Rate Per Pc.
RMI-G-513	5/16"	CC 200	OZ 8	Silvergrey	328.00

LEVER TYPE GREASE GUN

					
Cat No.	Piston	Capacity		Finish	Rate Per Pc.
RMI-G-4807	5/16"	CC 1000	OZ 32	Silvergrey	565.00

LEVER TYPE GREASE GUN (PROFESSIONAL SERIES)

Heavy Duty Type of Lubricants : Light or Medium Duty Grease				
Cat No.	Piston	Capacity		Rate Per Pc.
RMI-G-101B	1 1/32"	cc —	oz 15	536.00

LEVER TYPE GREASE GUN (PROFESSIONAL SERIES)

Heavy Duty Type of Lubricants : Light or Medium Duty Grease				
Cat No.	Piston	Capacity		Rate Per Pc.
RMI-G-101	1 1/32"	cc —	oz 15	518.00

PISTOL TYPE GREASE GUN

One Hand Operation					
Cat No.	Piston	Capacity		Finish	Rate Per Pc.
RMI-G-4808	3/8"	cc 450	oz 15	Matt Black/Texture Black	518.00

DELUXE MODEL OIL GUN

Push Type Hand Gun Type of Lubricants: Any type					
Cat No.	Piston	Capacity		Finish	Rate Per Pc.
RMI-G-503	—	cc 160	oz 6	Black Painted	280.00

MINI PISTOL TYPE GREASE GUN

One Hand Operation					
Cat No.	Piston	Capacity		Finish	Rate Per Pc.
RMI-G-4809	5/16"	cc 125	oz 3	Matt Black/Texture Black	308.00

DELUXE MODEL OIL GUN

Push Type Hand Gun Type of Lubricants: Any type					
Cat No.	Piston	Capacity		Finish	Rate Per Pc.
RMI-G-503S	—	cc 160	oz 6	Silver grey / BCP	290.00

GREASE CONTROL GUN

<p>Bar Pressure For use with Power Operated Equipments Provide Continuous Grease Flow By Pressing Full Trigger. Supplied With 6" Steel Extension Spout & High pressure Coupler</p>					
Cat No.	Piston	Capacity		Finish	Rate Per Pc.
RMI-G-512		cc	oz	Zinc / Bright / Black	951.00

PUSH TYPE GREASE GUN

Bedford / POM POM Type Type of Lubricants: Light Duty Grease					
Cat No.	Piston	Capacity		Finish	Rate Per Pc.
		cc	oz		
RMI-G-506	—	160	6	Silver grey or Black	145.00
RMI-G-506 (l)	—	200	8		168.00

PUSH TYPE GREASE GUN

Telescopic Type Type of Lubricants : Light Duty Grease					
					
Cat No.	Piston	Capacity		Finish	Rate Per Pc.
		cc	oz		
RMI-G-516	—	200	8	Silver grey or Black	263.00

SUCTION GUN

8" Flexible Hose Pipe with End fitting Type of Lubricants : Any type of Coolant & Gear Oil					
					
Cat No.	Piston	Capacity		Finish	Rate Per Pc.
		cc	oz		
RMI-G-4810	—	470	15	Silver grey/Nickle Bright	272.00
RMI-G-4810 A	—	1000	32	Zinc Bright	317.00

MINI PUSH TYPE GREASE GUN

Bedford / Pom Pom Type					
					
Cat No.	Piston	Capacity		Finish	Rate Per Pc.
		cc	oz		
RMI-G-511	—	100	4	Black	118.00

PUSH TYPE GREASE GUN

Telescopic Type Type of Lubricants : Light Duty Grease					
					
Cat No.	Piston	Capacity		Finish	Rate Per Pc.
		cc	oz		
RMI-G-517	—	150	8	Black	168.00

SUCTION OIL GUN

Oil Transfer Pump / C-Oil Gun with Rigid Gooseneck, for both Draining & Refilling					
					
Cat No.	Piston	Capacity		Finish	Rate Per Pc.
		cc	oz		
RMI-G-505	—	300	12	Black & White	263.00
RMI-G-505(i)	—	500	15	Black & White	299.00

HAND OPERATED TRANSFER PUMP

With 8 ft (2.4 Meter) Vinyl Hose for Suction & Discharge					
					
Cat No.	Piston	Capacity		Finish	Rate Per Pc.
		cc	oz		
RMI-G-4812	—	500	15	Red Oven Baked	502.00

SUCTION OIL GUN

8" Flexible Hose Pipe with End fitting Type of Lubricants : Any type of Coolant & Gear Oil					
					
Cat No.	Piston	Capacity		Finish	Rate Per Pc.
		cc	oz		
RMI-G-505A	—	300	12	Black Painted	276.00

SUCTION GUN

Plastic Body					
					
Cat No.	Piston	Capacity		Finish	Rate Per Pc.
		cc	oz		
RMI-G-12901	—	500	16	Orange Colour	136.00

AIR DUSTER



Cat No.	Air Pressure	Air Consumption	Rate Per Pc.
RMI-AD	45-75 PSI	40 PSI/5CFM	171.00

SILICON GUN

Smooth Rod Type | Half Round Type



Cat No.	Piston	Size	Finish	Rate Per Pc.
RMI-SG-9111		9 inch	Red/Blue Oven Baked	228.00

TYRE INFLATOR WITH GAUGE

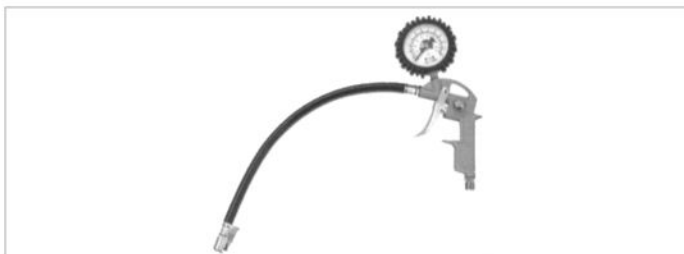

Cat No.	Capacity	Rate Per Pc.
RMI-TI	0-150 PSI	489.00

SILICON GUNS

Caulking Gun
(Half Round type & Skeleton Type)



Cat No.	Piston	Size	Finish	Rate Per Pc.
RMI-SG-9116	1/2"	9 inch	Red/Black Painted	157.00

CAULKING GUN



Cat No.	Product Description	Rate Per Pc.
RMI-1196	Caulking Gun	228.00

LEVER TYPE GREASE GUN HEAVY DUTY

Heavy Duty With Working Pressure 7000 PSI
Type of Lubricants : Light or Medium Duty Grease

New

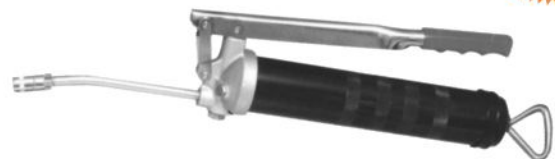

Cat No.	Piston	Capacity	Finish	Rate Per Pc.
RMI-G-515	5/16"	cc 445 oz 15	Black	542.00

HAND OPERATED BUCKET GREASE PUMP

HAND OPERATED BUCKET GREASE PUMPS



Cat No.	Capacity	Finish	Rate Per Pc.
RMI-BGP-3	3 kgs.	Red painted oven baked	3000.00
RMI-BGP-5	5 kgs.	Red painted oven baked	3400.00
RMI-BGP-10	10 kgs.	Red painted oven baked	4000.00
RMI-BGP-15	15 kgs.	Red painted oven baked	4450.00
RMI-BGP-20	20 kgs.	Red painted oven baked	5000.00
RMI-BGP-25	25 kgs.	Red painted oven baked	5350.00

AIR GREASE LUBRICATOR FITTED WITH HOSE & CONTROL



Cat No.	Capacity	Rate Per Pc.
RMI-A-675	50 kg	21220.00
RMI-A-670	35 kg	19780.00
RMI-A-609	25 kg	16460.00
RMI-A-610	15 kg	12890.00

HAND OPERATED BUCKET GREASE PUMPS

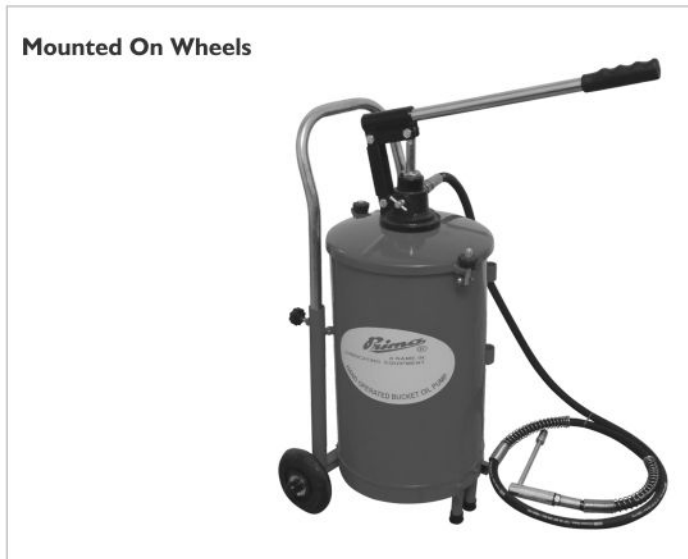

Cat No.	Capacity	Finish	Rate Per Pc.
RMI-BGPT-5	5 kgs.	Red gloss oven baked	3800.00
RMI-BGPT-10	10 kgs.	Red gloss oven baked	4300.00
RMI-BGPT-15	15 kgs.	Red gloss oven baked	4780.00
RMI-BGPT-20	20 kgs.	Red gloss oven baked	5400.00
RMI-BGPT-25	25 kgs.	Red gloss oven baked	5800.00

HAND OPERATED BUCKET OIL PUMPS

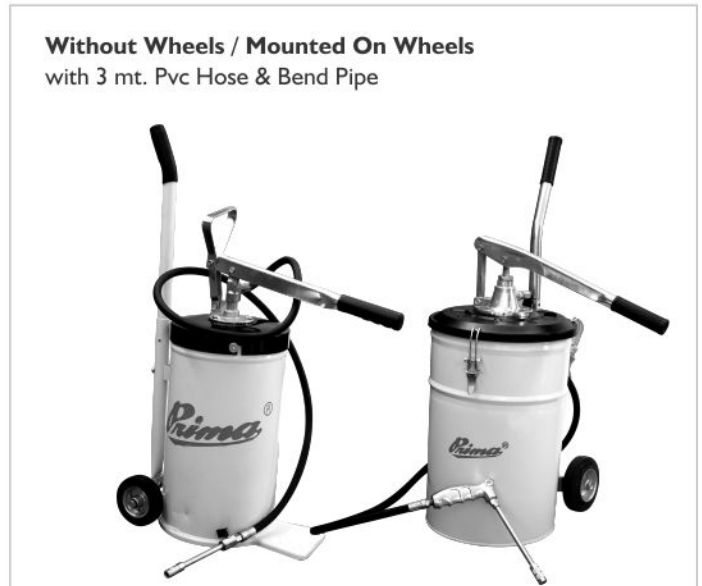

Cat No.	Capacity	Finish	Rate Per Pc.
RMI-BOP-25	25 Ltr.	Red gloss	3650.00
RMI-BOPT-25	25 Ltr.	Red gloss	4000.00
RMI-BOP-12	12 Ltr.	Red gloss	2950.00
RMI-BOPT-12	12 Ltr.	Red gloss	3640.00

HAND OPERATED BUCKET GREASE PUMP

HAND OPERATED BUCKET GREASE PUMPS



Cat No.	Capacity	Finish	Rate Per Pc.
	Mounted on Wheels		
RMI- BGP-6 (New)	6 kg Without Wheels	Red Painted oven baked	3500.00
RMI- BGP-10 (New)	10 kg Without Wheels	Red Painted oven baked	4000.00
RMI- BGPT-6 (New)	6 kg With Wheels	Red Painted oven baked	3950.00
RMI- BGPT-10 (New)	10 kg With Wheels	Red Painted oven baked	4300.00

FILLER PUMPS

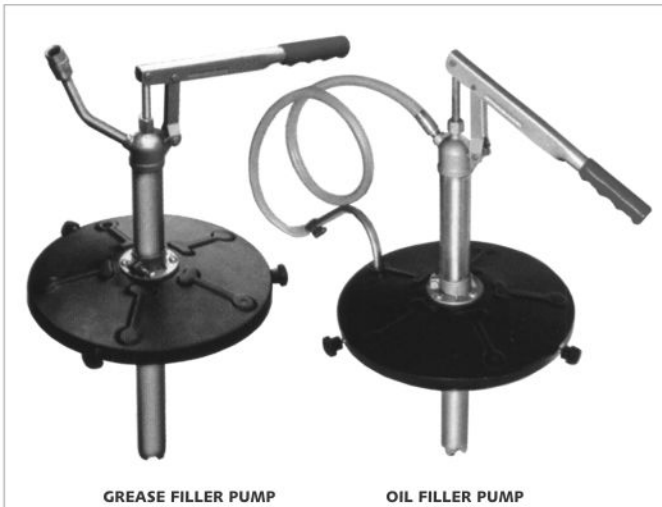

GREASE FILLER PUMP

OIL FILLER PUMP

Cat No.	Product Description	Rate Per Pc.
RMI-10360	Aluminium Cast Head Fitted with zinc plated suction tube and aluminium casted Flange. Useful For transferring thicker oils. Mat Black Powder coated cover. 4Ft PVC Hose Fitted with steel bend For discharge. Approximately delivers 1 pint per stroke (Without Bucket).	943.00
RMI-10361	Aluminium Cast Head Fitted with zinc plated suction tube and aluminium casted flange. An ideal Grease Pump For bulk Filling of Grease Gun. Mat Black Powder Coated Cover. Bend Spout Fitted with loader to Fit the Fillernipple. Available in 3 different capacities 12.5 Kgs., 20 Kgs. & 55 Kgs. pails (Without Bucket)	797.00

PNEUMATIC AIR OIL PUMP

Cat No.	Product Description	Rate Per Pc.
RMI-1211	3:1 Air Oil Pump Suitable for Transferring medium / high viscosity liquid at medium and long distance suitable for Drum size : 180-220 kgs.	12324.00

PNEUMATIC AIR GREASE PUMP

Cat No.	Product Description	Rate Per Pc.
RMI-1213	Air Grease ratio pump with hose & control Gun - 50:1	16431.00

DRUM DOLLIES

Heavy Duty Welded Steel Construction
With Powder Coated Finish
Suitable For use with 20Ltr/60Ltr Containers



Cat No.	Capacity to hold Gallon Containers	Finish	Rate Per Pc.
RMI-D-3 (Light)	5	Black Painted	480.00
RMI-D-4 (Heavy)	16	Silver Grey/BCP	659.00

SPARE HOSES & SPARE KIT

For Hand Operated Bucket Grease Pumps



Cat No.	Components	Rate Per Pc.
RMI-SP-45(1)	High Pressure Wire Braided Hose Dia 1/4" * 2.2Meter Long (Swivel Type) LG Type	956.00
RMI-SP-45	High Pressure Wire Braided Hose Dia 1/4" * 2.2Meter Long For Grease Bucket Pump Fitted with Rigid Spout & Hydraulic Coupon(Fixed Assembly)	896.00
RMI-SP-46	High Pressure Wire Braided Hose Dia 1/4" * 2.2Meter Long For Grease Bucket Pump without Accessories	831.00
RMI-Sparekit	Spare kit Comprising of 5Pcs Viz 1.Spring 2. Nylon Gland 3.Steel Ball 4. Filer Washer 5. Rubber Gasket.	56.00

GREASE GUN CONNECTORS



Cat No.	Product Description	Finish	Rate Per Pc.
RMI-SP-1	Thrust on Connector (Gun Metal)	Brass	117.00
RMI-SP-2	Hydraulic Adopter Heavy Duty/Coupler	B.C.P.	50.00
RMI-SP-5	Hook on Connector (Gun Metal)	Brass	118.00
RMI-SP-6	Adopter Coupler (3 Jaws)	B.C.P.	38.00
RMI-SP-7	Push type Connector (Female- Concave-Recess) Coupler For Grease Gun (Female)	B.C.P.	15.00
RMI-SP-9	Small	Zinc Bright	15.00
RMI-SP-17	Extra Long	Zinc Bright	22.00
RMI-SP-18	Hydraulic adopter/coupler German Type	B.C.P.	39.00
RMI-SP-10	Adopter/ Coupler For Pistol type, Handle type Grease	Zinc Bright	15.00
RMI-SP-15	Gun Coupler for Deluxe Model Oilgun	Zinc Bright	15.00
RMI-SP-26	Small	Zinc Bright	15.00
RMI-SP-27	Medium	Zinc Bright	15.00
RMI-SP-28	Extra Long	Zinc Bright	22.00

Cat No.	Product Description	Finish	Rate Per Pc.
RMI-SP-28A	Extra Long (From one end Hexagon & Round on Nozzle End) L Type Connector (Specially Designed to Lubricate Universal Joints)	Zinc Bright	23.00
RMI-SP-29	Male	Zinc Bright	23.00
RMI-SP-29A	Pointed male Extra Long	Zinc Bright	24.00
RMI-SP-30	Female	Zinc Bright	23.00
RMI-SP-31	Coupler For Standard & Giant Flush type Fitting used basically on hand gun For oil/grease gun as rigid coupling is required For Filling Lubrications.	Zinc Bright	15.00
RMI-SP-32	Connector For use on Grease gun with Concave recess to accommodate the canical tip of the nipple	Zinc Bright	15.00
RMI-SP-33	Male type Connector For use on Grease Gun/Oil guns	Zinc Bright	15.00
RMI-SP-34	Hydraulic Coupler Provides Quick Positive Leak proof connection with hydraulic Filings.	B.C.P.	39.00
RMI-SP-35	Grease Pressure Forces three hardened steel jaws. jaws are durable and long lasting	B.C.P.	39.00
RMI-SP-36	Extra Heavy Duty Hydraulic Adopter in single sealing & Gripping piston with ball check	B.C.P.	53.00
RMI-SP-37	Hydraulic Coupler has reversible Sure For 4 Jaws easy break away Features Jaws replaceable.	B.C.P.	38.00

QUICK CONNECT DISPENSERS



Cat No.	Product Description	Finish	Rate Per Pc.
RMI-SP-48	Available in Threads	Zine Bright	171.00
RMI-SP-49	1/8" BSP or 1/8"BSPT or 1/8"NPT or M10		171.00
RMI-SP-50			167.00
RMI-SP-51			123.00
RMI-SP-52			110.00
RMI-SP-53			86.00
RMI-SP-54			86.00
RMI-SP-55			86.00
RMI-SP-56			86.00

NEEDLE NOSE DISPENSERS



Cat No.	Product Description	Finish	Rate Per Pc.
RMI-SP-57	Recommended to be used with manual Grease Guns For Fine Greasing. New Design of Needle allows to reach grease Fitting in confined areas	Zine Bright	39.00
RMI-SP-58			45.00
RMI-SP-59			57.00

QUICK CONNECT HOSE



Cat No.	Product Description	Finish	Rate Per Pc.
RMI-SP-60	Fitted with grease nipple on one end of hose and coupler on other end		143.00



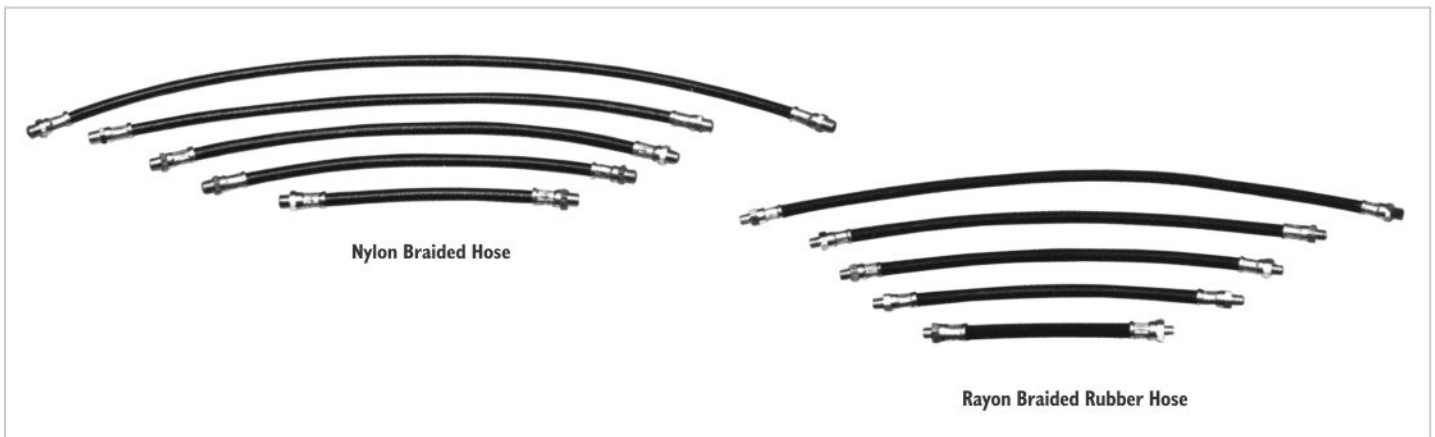















GREASE GUN FLEXIBLE PIPES



Rayan Braided Rubber or Nylon Braided PVC Coated Hosepipe For lever type Grease Gun with end Fitiing 1/8" BSP thread or threading as pr customers requirement

Cat No.	Product Description	Rate Per Pc.	
		Rubber Hose	Nylon Hose
RMI-SP-4	8"/200mm long	57.00	53.00
RMI-SP-4(i)	12"/300mm long	71.00	57.00
RMI-SP-4(ii)	15"/380mm long	86.00	67.00
RMI-SP-4(iii)	18"/450mm long	95.00	71.00
RMI-SP-4(iv)	24"/600mm long	104.00	86.00

GREASE GUN PIPES / CONNECTORS

					Cat No.	Product Description	Finish	Rate Per Pc.
RMI-SP-2A	RMI-SP-3	RMI-SP-8	RMI-SP-11	RMI-SP-11A	RMI-SP-2A	Hydraulic Heavy Duty Adopter with Rigid spout For Lever Type Grease Gun	BCP/Zinc	62.00
					RMI-SP-3	Adopter /Coupler with Spout For Lever Type Gun	Zinc Bright	47.00
RMI-SP-11B	RMI-SP-11C	RMI-SP-11D	RMI-SP-11E	RMI-SP-11F	RMI-SP-8	Cranked Steel Rigid Feed Tube 1/8" BSP with Lock Nut with pointed coupler	Nickle Bright	35.00
					RMI-SP-16	Flexible Pipe For Suction Gun C-Oil Gun 8" /200mm Long Fitted With nozzle		55.00
RMI-SP-16(i)	RMI-SP-16(ii)	RMI-SP-39	RMI-SP-40	RMI-SP-41	RMI-SP-16(i)	Bend Spout Goose Neck For Suction Gun	Nickle Bright	35.00
					RMI-SP-16(ii)	Bend Spout with special Nozzle For use For draining used in refilling inserts (textile Machine)	Nickle Bright	35.00
RMI-SP-42	RMI-SP-43	RMI-SP-44	RMI-SP-47		RMI-SP-11	Spout with Lock Nut For Lever type Grease Gun 6"	Zinc Bright	19.00
					RMI-SP-11A	Spout with Lock Nut For Lever type Grease Gun 7"	Zinc Bright	20.00
					RMI-SP-11 B	Extra Long Extension tube For reaching remote fittings with locking nut 14" Long	Zinc Bright	43.00
					RMI-SP-11 C	Nozzle Combined Straight Spout Threaded at the other end (Zinc Bright Finish)5"Long	Zinc Bright	17.00

Cat No.	Product Description	Finish	Rate Per Pc.
RMI-SP-11 D	Nozzle Combined Straight Spout Threaded at the other end (Zinc Bright Finish) Bent 9" Long	Zinc Bright	21.00
RMI-SP-11 E	Nozzle Combined Straight Spout Threaded at the other end (Zinc Bright Finish) Bent 6" Long	Zinc Bright	22.00
RMI-SP-11 F	Nozzle Combined Straight Spout Threaded at the other end (Zinc Bright Finish) Bent 9-1/2" Long	Zinc Bright	27.00
RMI-SP-39	Standard Filler Nipple 1/8" BSP	Zinc Bright	27.00
RMI-SP-40	Grease Nipple Extension 1/8" BSP Internal Thread	Zinc Bright	18.00
RMI-SP-41	Snap Hexagun Joint 1/8" BSP Internal Thread	Zinc Bright	18.00
RMI-SP-42	Snap on Handy Greasing Extension 1/8" BSP	Zinc Bright	68.00
RMI-SP-43	Universal Button Head Greasing Coupler 1/8" BSP	Zinc Bright	150.00
RMI-SP-44	Z. Type Connecor Uniiversal 360 Swivel Connecor	Zinc Bright	158.00
RMI-SP-47	Button Head Greasing Coupler 1/8" BSP	Zinc Bright	98.00

AIR RELEASE VALVE

	Cat No.	Product Description	Finish	Std. Packing	Rate Per Pc.
	RMI-SP-44A	Spare fitting for grease gun. Air can be released by pressing the pin.	Chrome Plated Zinc Plated	1Pcs.	29.00

RIGHT ANGLE COUPLER

	Cat No.	Product Description	Finish	Std. Packing	Rate Per Pc.
	RMI-SP-49	Useful where space is confined and other coupler are difficult to fit. Fitted with most of grease gun	Chrome Plated Zinc Plated	1Pcs.	132.00

PIN TYPE NIPPLE

	Cat No.	Product Description	Finish	Std. Packing	Rate Per Pc.
	RMI-SP-45A	Pin constructed grease nipple. Hexagonal nut for easy tightening.	Chrome Plated Zinc Plated	1Pcs.	39.00

PIN TYPE COUPLER

	Cat No.	Product Description	Finish	Std. Packing	Rate Per Pc.
	RMI-SP-47A	Gives quick & leakproof fitting with pin type nipple. Hex nut for easy tightening	Chrome Plated Zinc Plated	1Pcs.	64.00

GREASE NIPPLES



RMI-GN-150



RMI-GN-120 S



RMI-GN-170 A



RMI-GN-170



RMI-GN-110



RMI-GN-312



RMI-GN-116



RMI-GN-111



RMI-GN-112



RMI-GN-501



RMI-GN-502



RMI-GN-303



RMI-GN-304



RMI-GN-316

Unified Fine Threads UNF - Threads

Cat No.	Threads	Type	Rate Per 100 Pc.
RMI-GN-150	1/4"UNF	Straight	402.00
RMI-GN-170	1/4"UNF	45 Degree Bent	777.00
RMI-GN-170 A	1/4"UNF	45 Degree Bent	777.00
RMI-GN-120S	1/4"UNF	90 Degree Bent	777.00
RMI-GN-119	1/4"UNF	90 Degree Bent	777.00
RMI-GN-117	5/16"UNF	Straight	427.00
RMI-GN-118	5/16"UNF	46 Degree Bent	783.00

National Pipe Taper Threads - NPT Threads

Cat No.	Threads	Type	Rate Per 100 Pc.
RMI-GN-110	1/8"NPT	Straight	584.00
RMI-GN-111	1/8"NPT	30 Degree Bent	849.00
RMI-GN-112	1/8"NPT	45 Degree Bent	849.00
RMI-GN-116	1/8"NPT	90 Degree Bent	849.00
RMI-GN-312	1/4"NPT	Straight	1199.00
RMI-GN-313	1/4"NPT	45 Degree Bent	1407.00
RMI-GN-311	1/4"NPT	90 Degree Bent	1407.00

British Standard Pipe BSP

Cat No.	Threads	Type	Rate Per 100 Pc.
RMI-GN-303	1/8"BSP	Straight	595.00
RMI-GN-304	1/8"BSP	45 Degree Bent	895.00
RMI-GN-306	1/8"BSP	90 Degree Bent	895.00
RMI-GN-317 A	1/8"BSP	90 Degree Bent	895.00
RMI-GN-314	1/4"BSP	Straight	1199.00
RMI-GN-315	1/4"BSP	45 Degree Bent	1377.00
RMI-GN-316	1/4"BSP	90 Degree Bent	1377.00



RMI-GN-235



RMI-GN-222



RMI-GN-210



RMI-GN-203



RMI-GN-229



Metric Threads

Cat No.	Threads	Type	Rate Per 100 Pc.
RMI-GN-235	M6 x1	Straight	386.00
RMI-GN-222	M8 x1	Straight	433.00
RMI-GN-210	M10 x1	Straight	595.00
RMI-GN-238	M6 x1	45 Degree Bent	783.00
RMI-GN-224	M8 x1	45 Degree Bent	895.00
RMI-GN-212	M10 x1	45 Degree Bent	910.00
RMI-GN-229	M6 x1	90 Degree Bent	783.00
RMI-GN-203	M8 x1.25	90 Degree Bent	935.00
RMI-GN-208H	M10 x1	90 Degree Bent	910.00
RMI-GN-236 S	M6 x1	90 Degree Bent	783.00
RMI-GN-207 S	M8 x1	90 Degree Bent	895.00
RMI-GN-208 S	M10 x1	90 Degree Bent	910.00

Industrial Round Button Head

Cat No.	Threads	Type	Rate Per 100 Pc.
RMI-GN-501	1/8"BSP	Straight	1311.00
RMI-GN-502	1/4"BSP	Straight	1581.00
RMI-GN-504	1/8"BSP	Straight	1327.00
RMI-GN-511	M10 x1	Straight	1327.00











ACCESSORIES FOR HAND ROTARY PUMP

		
R-201 (18) BARREL PUMP BEND	R-201 (19) FLEXIBLE DELIVERY PIPE	R-201 (23) DRUM NUT
Cat No.	Product Description	Rate Per Pc.
RMI-R-201(20)	Heavy duty flexible delivery pipe (1 Mtr. long Rubber hose/PVC hose with steel discharge bent spout)	327.00
RMI-R-201(19)	Hose clamp for tightening rubber hose & steel discharge bent spout of flexible delivery pipe	39.00
RMI-R-201(18)	Barrel pump Bend-Heavy constructed steel pipe (Printed or chrome plated)	73.00
RMI-R-201(23)	Drum nut-sand casting components used with barrel pump with 2" BSP standard thread	73.00
RMI-R-201(12)	Handle for Rotary pump sand casting	107.00

FOOT OPERATED AIR PUMPS ACCESSORIES

		
RMI-BC01	RMI-BC02	
Cat No.	Product Description	Rate Per Pc.
RMI-BC01	Ball Foot chuck with clip	127.00
RMI-BC02	Air Chuck	93.00

SYNTHETIC RUBBER WASHERS

					
RMI-SP-12	RMI-SP-13	RMI-SP-14	RMI-SP-19	RMI-SP-20	RMI-SP-21
					
RMI-SP-22	RMI-SP-23	RMI-SP-24	RMI-SP-38		
Cat No.	Product Description	Finish	Rate Per Pc.		
RMI-SP-12	For Lever Type Grease Gun G-501/507/510	Natural	22.00		
RMI-SP-13	For Bed Ford type Grease	Natural	15.00		
RMI-SP-14	For Grease Gun G-504/505/513/C-Oil Gun	Natural	20.00		
RMI-SP-19	For Grease Gun G-500/A-1010/A-1019	Natural	22.00		
RMI-SP-20	For Mini Push Type	Natural	11.00		
RMI-SP-21	For Grease Gun G-509	Natural	17.00		
RMI-SP-22	For Grease Gun G-503	Natural	17.00		
RMI-SP-23	For G-4808 Pistol Grease Gun	Natural	22.00		
RMI-SP-24	For Mini Lever Type Grease Gun G-502	Natural	11.00		
RMI-SP-25	For Mini Pistol Type Grease Gun G-4809	Natural	11.00		
RMI-SP-38	For Grease Gun G-4806	Natural	22.00		

SUCTION TUBE FOR HAND ROTARY PUMP

		
R-203/R-204 (21)		
R-203/R-204 (21)		
R-201 (21)		
Cat No.	Product Description	Rate Per Pc.
RMI-R-201(21)	01-1/4 X 16G, IMT. Long, ERW Steel pipe tube used with 1" outlet Capacity Hand Rotary Pump	220.00
RMI-R-203/204(21)-2	For Hand Rotary with 2 Pcs sections	250.00
RMI-R-203/204(21)-3	For Hand Rotary with 3 Pcs sections	220.00

HIGH PRESSURE METAL OIL CANS



Wesco type

Cat No.		Capacity	Rate Per Dozen	
Rigid Spout	Flexible Spout		Rigid Spout	Flexible Spout
RMI-R-100	RMI-R-122	1/4 Pint	887.00	959.00
RMI-R-101	RMI-R-123	1/2 Pint	1045.00	1123.00
RMI-R-102	RMI-R-124	3/4 Pint	1137.00	1205.00
RMI-R-103	RMI-R-125	1 Pint	1268.00	1341.00
RMI-R-104	RMI-R-126	1.1/2 Pint	1445.00	1535.00
RMI-R-105	RMI-R-127	2 Pint	2074.00	2164.00

Perfetto Type (Thumb Lever action solid steel pump with fixed/detachable spout)

Cat No.		Capacity	Rate Per Dozen	
Rigid Spout	Flexible Spout		Rigid Spout	Flexible Spout
RMI-R-116	RMI-R-116 A	200 CC	929.00	1009.00
RMI-R-117	RMI-R-117 A	300 CC	1078.00	1156.00
RMI-R-118	RMI-R-118 A	500 CC	1214.00	1292.00
RMI-R-119	RMI-R-119 A	700 CC	1440.00	1535.00
RMI-R-120	RMI-R-120 A	1000 CC	2078.00	2164.00

HAND OPERATED PISTOL OILERS

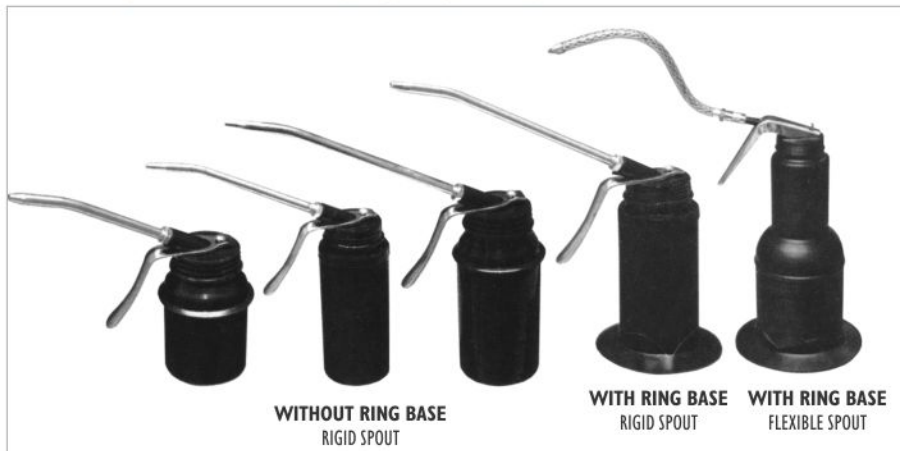

Made From seamless heavy Gauge steel body Forced Feed Pump with two steel ball valves, Steel pump. pump parts are removable For easy cleaning powder coated oven baked

With Base Ring

Cat No.	Name	Capacity	Rate Per Dozen
RMI-R-0108	Pistol Pump Oiler With base ring Rigid Spout	150 CC	690.00
RMI-R-0109	Pistol Pump Oiler With base ring Rigid Spout	180 CC	639.00
RMI-R-0112	Long Neck Pistol Oiler long Rigid Spout	500 CC	1006.00
RMI-R-0112A	Long Neck Pistol Oiler Flex. Spout	500 CC	1058.00

Hand Operated

RMI-R-12IS	Pistol Oiler	150cc	690.00
RMI-R-12IJ	Pistol Oiler	150cc	647.00
RMI-R-950	Plastic Bocy Pistol Oiler fitted Pressure Pump	150cc	497.00
RMI-R-951	Plastic Bocy Pistol Oiler fitted Pressure Pump	500cc	591.00

HIGH PRESSURE PLASTIC BODY OILERS

Plastic Body Pump Oilers Fitted with Nylon Pump Mechanism with Fixed/Flexible spout

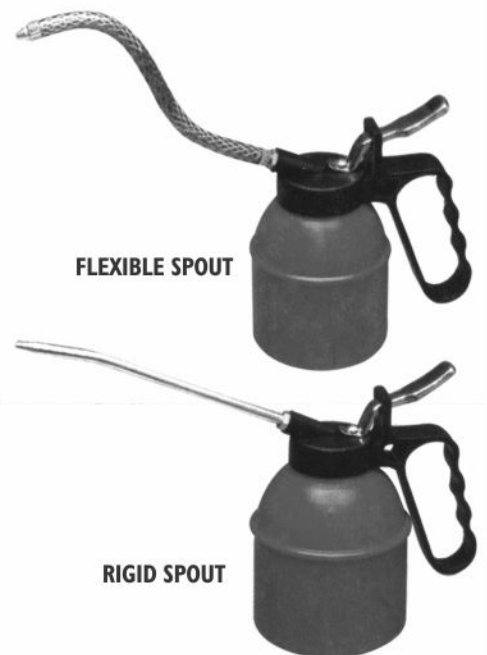

Cat No.	Capacity	Rate Per Dozen	
		Fixed Spout	Flexible Spout
RMI-POP-300	300 CC	684.00	743.00
RMI-POP-500	500 CC	802.00	860.00

PLASTIC BODY HAND OPERATED OILERS

FORCED FEED TYPE



Cat No.	Name	Capacity	Rate Per Dozen
RMI-R-990(I)	Plastic Bench Oiler	125CC	259.00
RMI-R-990(II)	Plastic Bench Oiler	250CC	315.00
RMI-R-990(III)	Plastic Bench Oiler	500CC	407.00

BENCH OILER



Cat No.	Name	Capacity	Rate Per Dozen
RMI-R-0110	Bench Oiler Snap Bottom(Metal Body) Rigid Spout	12 Oz	722.00

SPOUTS

FOR OILERS



Cat No.	Product Description	Length	Rate Per Dozen	
			Rigid Spout	Flexible Spout
-	For 1/4Pint Oil Pump	125 mm	97.00	145.00
-	For 1/2 Pint Oil Pump	150 mm	109.00	162.00
-	For 3/4 Pint Oil Pump	150 mm	109.00	162.00
-	For 1 Pint Oil Pump	160 mm	118.00	185.00
-	For 1.1/2 Pint Oil Pump	175 mm	145.00	199.00
-	For 2 Pint Oil Pump	185 mm	176.00	225.00

FUNNELS & MEASURES



Cat No.	Product Description	Rate Per Pc.
-	4" Funnels	27.00
-	6" Funnels	39.00
-	7" Funnels	49.00
-	10" funnels	97.00
-	1.5Ltr. Measure Without Hose	82.00
-	1 Ltr Measure With hose & lid	97.00
-	2 Ltr Measure With hose & lid	111.00
-	3 Ltr Measure With hose & lid	127.00
-	5 Ltr Measure With hose & lid	169.00
-	6" Funnels with hose & lid	76.00
-	9" Funnels with hose & lid	122.00
-	Garage Funnel	178.00

HAND PUMPS



Cat No.	Product Description	Rate Per Pc.
RMI-R-200	Hand Rotary Pump Extra Heavy Duty 1.1/2 Outlet Capacity 500CC per rev. delivery upto 15-20 Ft	2583.00
RMI-R-201	Hand Rotary Pump 1" outlet Capacity ERW pipe on suction & chrome plated on delivery side	1385.00
RMI-R-202	Hand Rotary Pump 3/4" outlet Capacity ERW pipe on suction & chrome plated on delivery side	1210.00
RMI-R-203	Hand Rotary Pump with telescopic pipe 1" without Flexible outlet hose.	1444.00
RMI-R-203 A	Hand Rotary Pump with telescopic pipe 1" with Flexible outlet hose 1 meter long	1537.00
RMI-R-204	Hand Rotary Pump with telescopic pipe 3/4" with Flexible outlet hose 1 meter long	1355.00
RMI-R-204 A	Hand Rotary Pump with telescopic pipe 3/4" without Flexible outlet hose	1268.00
RMI-R-205	Simple Barrel Pump with locking device 1/2" suction pipe ERW quality in 16 SWG	998.00
RMI-R-207	Barrel Pump Made stainless steel , used For pumping & Chemicals From drums of 200 Ltrs	7684.00
RMI-R-250	Hand Rotary Pump Heavy dudy 1.1/4" outlet cap..300c Discharge per Rev.,delivery up to 15ft.	2251.00
RMI-R-300	Hand Rotary Pump 3" suction & 3" delivery suitable For pumping lubricants From tank (with bend end pipe)	3905.00
RMI-R-301	This hand pumps made Stainless Steel (SS-304) For weak / strong acid & alkali liquids, resists nitric acids 40% Gasoline, Diesel,Fuel, Alcohol & Thinner, Chemical Liquids, Delivery 5 Ltrs. per 20 rotations	11150.00
RMI-R-302	This hand pumps made Stainless Steel (SS-316) For weak / strong acid & alkali liquids, resists nitric acids 40% Gasoline, Diesel,Fuel, Alcohol & Thinner, Chemical Liquids, Delivery 5 Ltrs. per 20 rotations	14661.00
RMI-J-3015	Hand Lever actions drum pump for oil transfer delivers upto 0.45Ltrs.RPM	1077.00
RMI-J-3016	Lever oil pump used for pumping gasoline, Gear oil, Diesel, Light oil, Kerosene	1077.00

HAND PUMPS

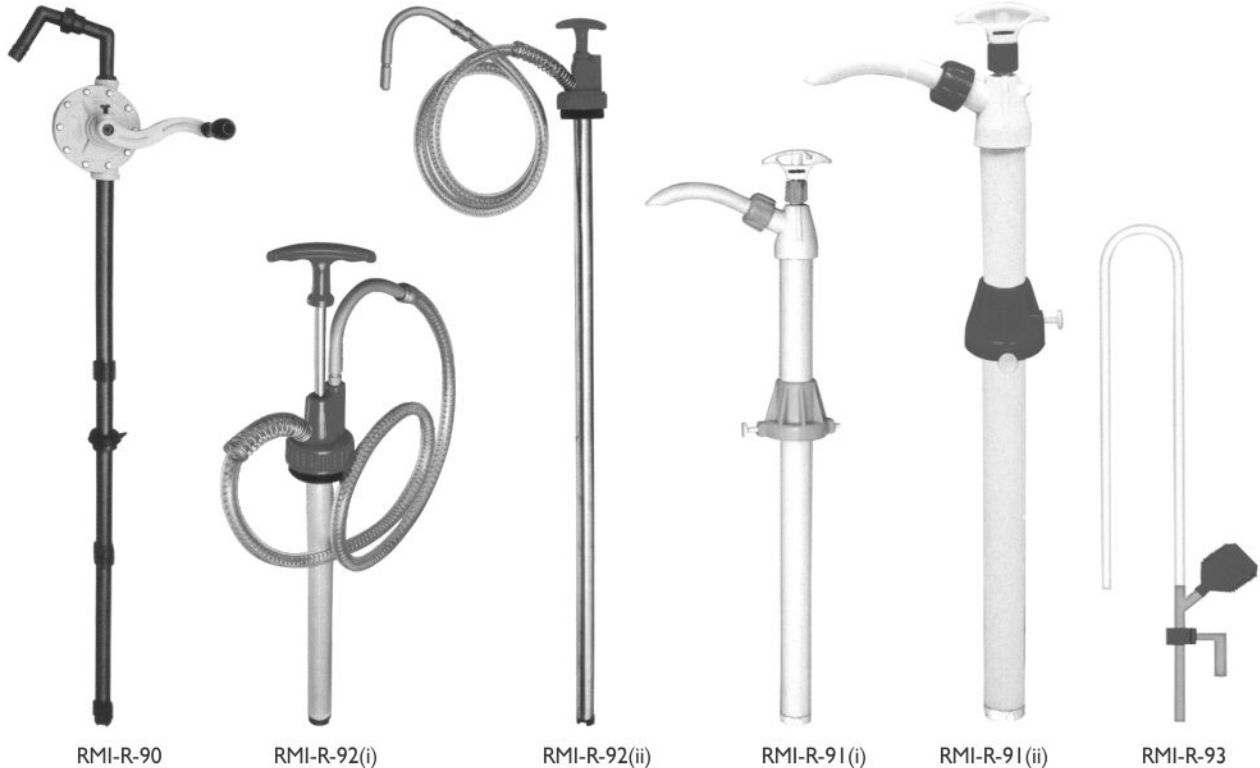

PLASTIC PUMPS FOR HANDLING CHEMICALS		
RMI-R-90	All plastic rotary pump superior chemical resistant and effortless operation pump are supplied with 1" discharge spout 3 Pcs.47" long suction tube stainer & 2"NPT Polythene Adopter	2895.00
RMI-R-91(i)	Hand Pump Plastic For chemical, thinner, cleaning agents, Antifreeze 20Ltr. Capacity	525.00
RMI-R-91(ii)	Hand Pump Plastic For chemical, thinner, cleaning agents, Antifreeze with two suction tube lengths For 200Ltr capacity	565.00
RMI-R-92(i)	Lift Action Piston Pump down Stroke acting piston pump For 20Ltr capacity. For 20Ltr Drum Pump. Non Drip Nozzle For gear oil. Drain back Nozzle Holder to Ensure that excess oil grease on your workshop Floor. Dispeses output on the down stroke. 14stroke per Ltr	616.00
RMI-R-92ii	Lift Action Piston pump down stroke acting piston pump For 50Ltr capacity	661.00
RMI-R-93	Mega Pump very Simple Method to transfer Liquid (Single Pcs Packing in Poly bag)	407.00

AIR OPERATED GREASE GUN

40 : 1 ratio air motor. Heavy duty head Construction for durability and long life. Rapid spin barrel threads for fast cartridge Replacement. 3-way loading bulk. Filler pump Or cartridge. Bleeder valve for purging Unwanted air. Durable follower rod 7 spring for Consistent priming. 4 jaw super grip coupler For better grip and longer service life.



Cat No.	Piston	Pressure	Capacity		Finish	Std. Packing	Rate Per Pc.
			cc	oz			
RMI-1027	3/8"	4800PSI/ 330BAR	470	15	Nickle Bright	12 Pcs.	2460.00

AIR ENGINE CLEANING GUN/OIL SPRAY GUN

For Engine Cleaning



Cat No.	Capacity	Finish	Std. Packing	Rate Per Pc.
	cc oz			
RMI-D09CE	3.5 CFM	Red	2 Pcs.	729.00

HIGH PRESSURE SPRAY GUN

High efficiency transfer from medium to high viscosity materials in a wide variety of home improvement projects. Well processing for air cap. set, nozzle & needle for fine atomization. Durable nozzle & needle offer stable performance for long terms.



Type of feed: Gravity
Standard Nozzle: ∅ 1.8 mm
Optional Nozzle: ∅ 1.5/1.8/2.0 mm

Cat No.	Point Capacity	Rate Per Pc.	Cat No.	Point Capacity	Rate Per Pc.
RMI-W-71G	600ML	1230.00	RMI-W-71G	400ML	1123.00

5-IN-1 AIR TOOL KIT

Mainly used for car maintaining. It can supply spray painting, blowing off dust, pumping air to cars



1. Quality Paint Spray Gun
Nozzle: 1.5mm Air Pressure: 45-55 PSI
Air Consumption: 40 PSI/ 5 CFM



2. Air Duster
Air Pressure: 45-75 PSI
Air Consumption: 40 PSI/5 CFM



3. Recoil Air Hose
Length: 5 mtr.
Capacity: Upto 170 PSI



4. Tyre inflator with gauge
Capacity: 0-150 PSI



5. Engine Cleaning Gun
Air Pressure: 30-35 PSI Air
Consumption: 30 PSI/3.5 CFM



Cat No.	Product Description	Std. Packing	Rate Per Pc.
RMI-FS-500A	5 Pcs. Air Tool Kit Consists of	1 Kit	2345.00
	• Paint Spray Gun • Air Duster • Recoll Air Hose		
	• Tyre inflator with gauge • Engine cleaning gun		

FOOT PUMPS & ACCESSORIES



Cat No.	Product Description	Rate Per Pc.
RMI-FP-002	Heavy Duty Single Barrel Foot Pump with Dia 2 1/4"	928.00
RMI-R-005	Air Chuck Having a Short stem Made From Brass	122.00
RMI-R-006	Air Chuck Having a Long stem Made From Brass	159.00
RMI-R-007	Twin Connector Specially Designed For Inflation to twin tyres but are ideal For all tyre valves	179.00
RMI-R-008	Cycle & Motor cycle Air chuck valve 10mm/8mm	160.00
RMI-R-009	Tata Air Wring Nut	71.00
RMI-PSG-221	Portable tyre Pressure gauge Pressure Range 0-100LBS	374.00
RMI-PSG-225	Pressure Gauge of Air, water, oil etc. 4"-102mm (0-15 PSI to 0-1000 Psi) 3/8" BSP Thread	517.00
RMI-R-010	Tyre Tube valve Die	27.00
RMI-R-011	Inflater and Gauge Kit	475.00

PRESSURE GAUGE



Model No. : RMI-1214
 Size : 51mm (2inch)
 Case : MS Drawn Case and Bezel with Rubber Cover Available in bristle Packing
 Application : Tyre Air Checking of Tractor, Scooter, Motor & Light Vehicle
 Rate per Pc. : 289.00



Model No. : RMI-1215
 Size : 51mm (2inch)
 Range : 50, 100, 150 & 200 psi
 Application : Air Pressure Checking of Heavy Vehicles Tyre.
 Rate per Pc. : 338.00



Model No. : RMI-1216
 Size : 64mm (2.5 inch)
 Range : 50, 100, 150 & 200 psi
 Application : Air Pressure Checking of Heavy Vehicles Tyre.
 Rate per Pc. : 435.00



Model No. : RMI-1217
 Size : 51mm (2 inch)
 Range : 50, 100, 150 & 200 psi
 Application : Air Pressure Checking of Light Vehicles Tyre.
 Rate per Pc. : 334.00

HIGH FLOW PUMP

RMI launched following range HAND PUMPS for handling

- Water Gasoline, Diesel, kerosene, Lubricant, Solvents, Ethyl Alcohol
- Water based chemicals, Acids & Alkaline solutions.

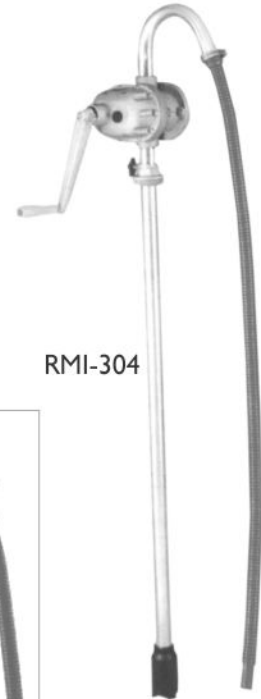

RMI-304



RMI-304

Specifications:

Pump Type : Rotary - Gear
 Flow : 1L / Stroke
 Mounting : 2" MNPT Bung Adapter
 Suction Tube Length : 40" Maximum
 Inlet : 1-1/4" O.D.
 Outlet : 1" O.D. Curved Spout
 Wetted Parts : Cast Aluminum, Plated Steel, NBR & PE Maximum
 Viscosity : 500 SSU (or SAE 30)

Features:

- » Commonly used for dispensing or transferring low viscosity and non-corrosive petroleum based fluids, such as Petrol, Diesel, Kerosene, Lube, Fuel, Machine Oil, etc.
- » Supply with 2" bung adapter and 40" long plated steel suction tube to fit most 15, 30 and 55 gallon drums. Self-priming unit, dispenses approximately 1 liter per stroke.
- » Do not use with organic solvents, alkalis, acids and water-based fluids.
- » Supply with suction filter to sift the dirt and ensure pump life.

Cat No.	Size	Suction Tube	Product Description	Std. Packing	Rate Per Pc.
RMI-304	1"		One liter per rotation and 100 liters per minute.	5 Pcs.	15500.00
			Vertical conveying distance : 15m.		
			Horizontal conveying distance : 50m		

FOOT PUMPS & ACCESSORIES



Cat No.	Product Description	Rate Per Pc.
RMI-FP-002	Heavy Duty Single Barrel Foot Pump with Dia 2 1/4"	928.00
RMI-R-005	Air Chuck Having a Short stem Made From Brass	122.00
RMI-R-006	Air Chuck Having a Long stem Made From Brass	159.00
RMI-R-007	Twin Connector Specially Designed For Inflation to twin tyres but are ideal For all tyre valves	179.00
RMI-R-008	Cycle & Motor cycle Air chuck valve 10mm/8mm	160.00
RMI-R-009	Tata Air Wring Nut	71.00
RMI-PSG-221	Portable tyre Pressure gauge Pressure Range 0-100LBS	374.00
RMI-PSG-225	Pressure Gauge of Air, water, oil etc. 4"-102mm (0-15 PSI to 0-1000 Psi) 3/8" BSP Thread	517.00
RMI-R-010	Tyre Tube valve Die	27.00
RMI-R-011	Inflater and Gauge Kit	475.00

HIGH FLOW PUMP

RMI launched following range HAND PUMPS for handling

- Water Gasoline, Diesel, kerosene, Lubricant, Solvents, Ethyl Alcohol
- Water based chemicals, Acids & Alkaline solutions.



RMI-304



RMI-304

Specifications:

Pump Type : Rotary - Gear
 Flow : 1L / Stroke
 Mounting : 2" MNPT Bung Adapter
 Suction Tube Length : 40" Maximum
 Inlet : 1-1/4" O.D.
 Outlet : 1" O.D. Curved Spout
 Wetted Parts : Cast Aluminum, Plated Steel, NBR & PE Maximum
 Viscosity : 500 SSU (or SAE 30)

Features:

- » Commonly used for dispensing or transferring low viscosity and non-corrosive petroleum based fluids, such as Petrol, Diesel, Kerosene, Lube, Fuel, Machine Oil, etc.
- » Supply with 2" bung adapter and 40" long plated steel suction tube to fit most 15, 30 and 55 gallon drums. Self-priming unit, dispenses approximately 1 liter per stroke.
- » Do not use with organic solvents, alkalis, acids and water-based fluids.
- » Supply with suction filter to sift the dirt and ensure pump life.

Cat No.	Size	Suction Tube	Product Description	Std. Packing	Rate Per Pc.
RMI-304	1"		One liter per rotation and 100 liters per minute.	5 Pcs.	15500.00
			Vertical conveying distance : 15m.		
			Horizontal conveying distance : 50m		

PRESSURE GAUGE



Model No. : RMI-1214
 Size : 51mm (2inch)
 Case : MS Drawn Case and Bezel with Rubber Cover Available in bristle Packing
 Application : Tyre Air Checking of Tractor, Scooter, Motor & Light Vehicle
 Rate per Pc. : 289.00



Model No. : RMI-1215
 Size : 51mm (2inch)
 Range : 50, 100, 150 & 200 psi
 Application : Air Pressure Checking of Heavy Vehicles Tyre.
 Rate per Pc. : 338.00



Model No. : RMI-1216
 Size : 64mm (2.5 inch)
 Range : 50, 100, 150 & 200 psi
 Application : Air Pressure Checking of Heavy Vehicles Tyre.
 Rate per Pc. : 435.00



Model No. : RMI-1217
 Size : 51mm (2 inch)
 Range : 50, 100, 150 & 200 psi
 Application : Air Pressure Checking of Light Vehicles Tyre.
 Rate per Pc. : 334.00

Terms & Conditions

1. All Orders will be accepted in standard packing only.
2. Price are F.O.R Ludhiana.
3. GST will be charged extra as applicable .
4. We reserve the right to cancel any order or despatch the order in Full or in part subject to availability of stocks.
5. Our responsibility ceases on delivery of consignment to the carriers & receipt obtained.
6. Order should be accompanied with 20% advance by Bank Draft payable at Ludhiana.
7. We reserve the right to revise the price without any notice.
8. Interest @ 12% p.a will be charged if payment of bill will not reach us within 30 days from the date of bill.
9. All disputes are subject to Ludhiana Jurisdiction Only.



Prima®

A NAME IN LUBRICATION EQUIPMENT

RAJEEV METAL INDUSTRIES

📍 C-3, Textile Colony, Industrial Area-A, Ludhiana-141 003 (Pb.) INDIA

☎ +91-161-5030680 to 688

✉ prima0008@gmail.com, primarmi8@gmail.com

🌐 www.primatools.com